

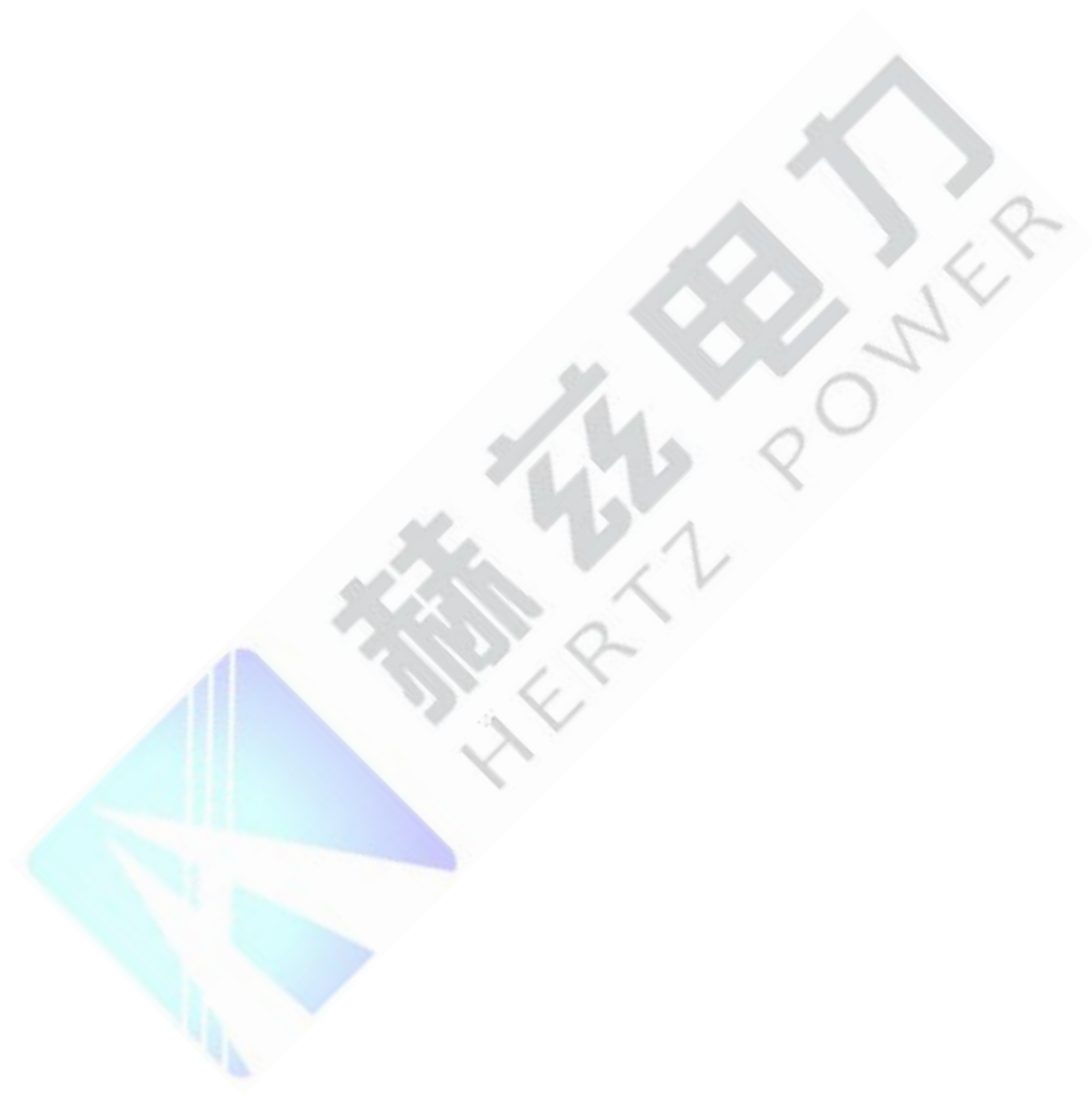

赫兹电力  
HERTZ POWER

产品宗旨：技术领先，质量可靠，轻便易用

服务宗旨：快速响应，时间到满意，超过期





赫兹电力

HERTZ POWER

产品宗旨: 技术领先, 质量可靠, 易于使用

宗旨: 快速响应, 客户满意

# 发电机组

www.whezi.com

赫兹电力  
HERTZ POWER

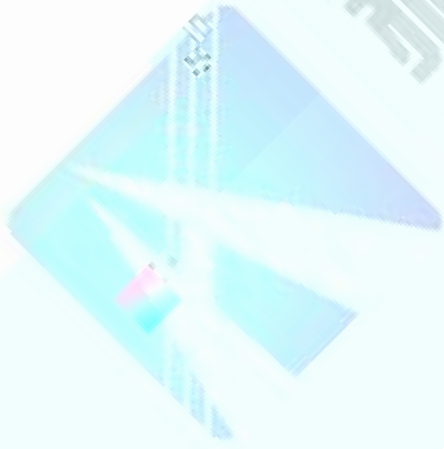



赫兹电力  
HERTZ POWER



- 1.
- 2. \*
- 3.
- 4.
- 5.
- 6. "
- 7. = +
- 8.
- 9.
- 10.
- 11.
- 12.
- 13.
- 14.
- 15. /

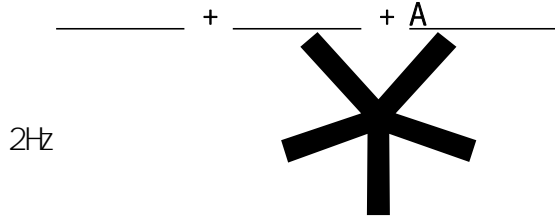

赫兹电力  
HERTZ POWER

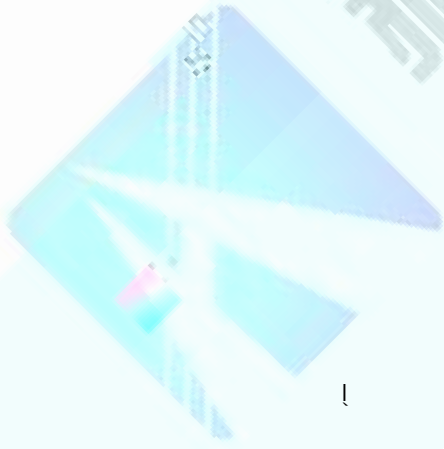





A.

- 1.
2. 640Hz 1280Hz 8kHz 33kHz 82kHz 197kHz
3. 15Wmax 10
- 4.
- 5.
6. 320x 240 LCD
7. 7.4V >6Ah
8. AC100- 240V 50/60Hz
9. DC8.4V 2A
10. 280x 220x 90mm
11. 2.3kg
12. IP65
13. -25 60 <90%RH <4500m







B.

1. A
- 2.
3. 640Hz 1280Hz 8kHz 33kHz 82kHz 197kHz
4. 50/60Hz 4- 24kHz
5. 320x 240 LCD
6. 7.4V >3Ah
7. AC100- 240V 50/60Hz
8. DC8.4V 2A
9. 680x 120x 277mm
10. 2.0kg
11. IP65
12. -25 60 <90%RH <4500m

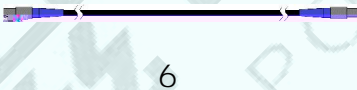
赫兹电力  
HERTZ POWER

1			1
2			2
3			1
4			2

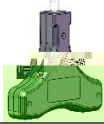
4

1			
2			
3			
3			
4			
5			
6			
7	A		

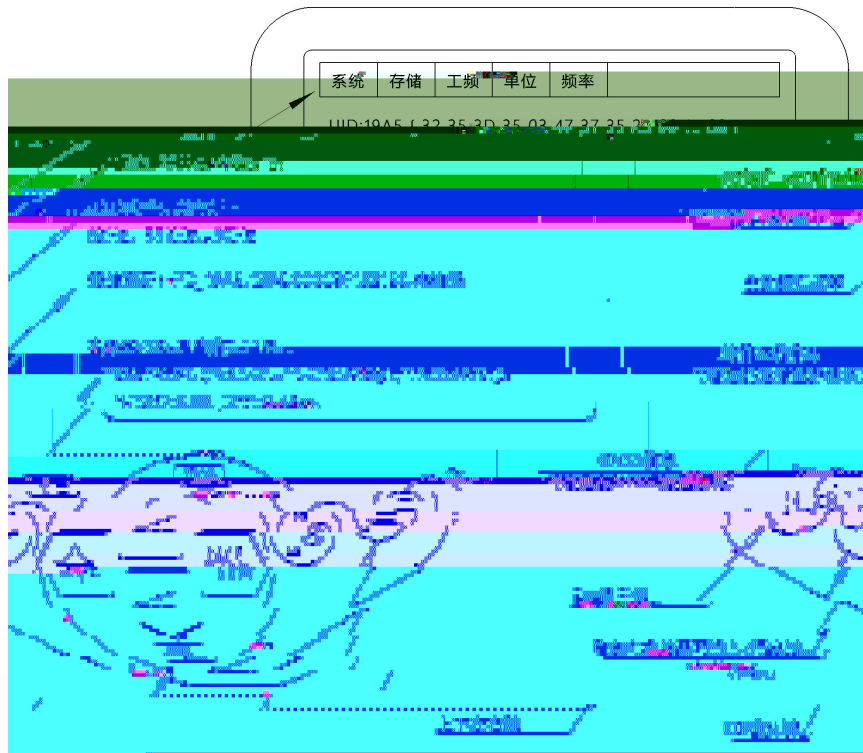

1-6-1

- 1.
- 2.
- 3.
- 4.
- 5.



/

OK

ESC

UI D

GNSS

GNSS

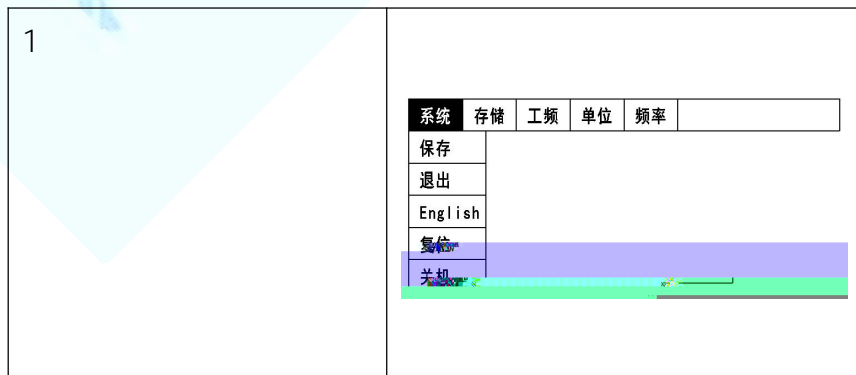

2

系统	存储	工频	单位	频率
发送全部				

3

50 60Hz

系统	存储	工频	单位	频率
[Data]				

4

m

系统	存储	工频	单位	频率
			* m	

ft

5

赫兹电力  
HERTZ POWER

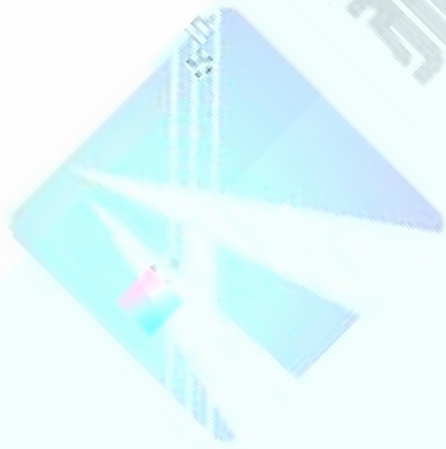

赫兹电力  
HERTZ POWER

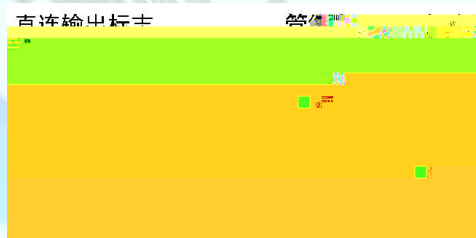

2-1-3

50V

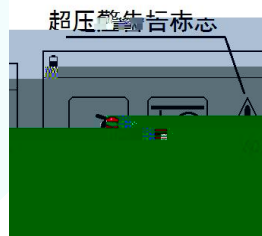

2-1-4

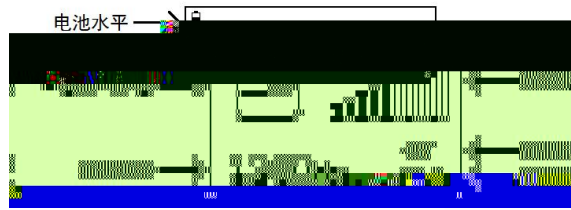

2-1-5

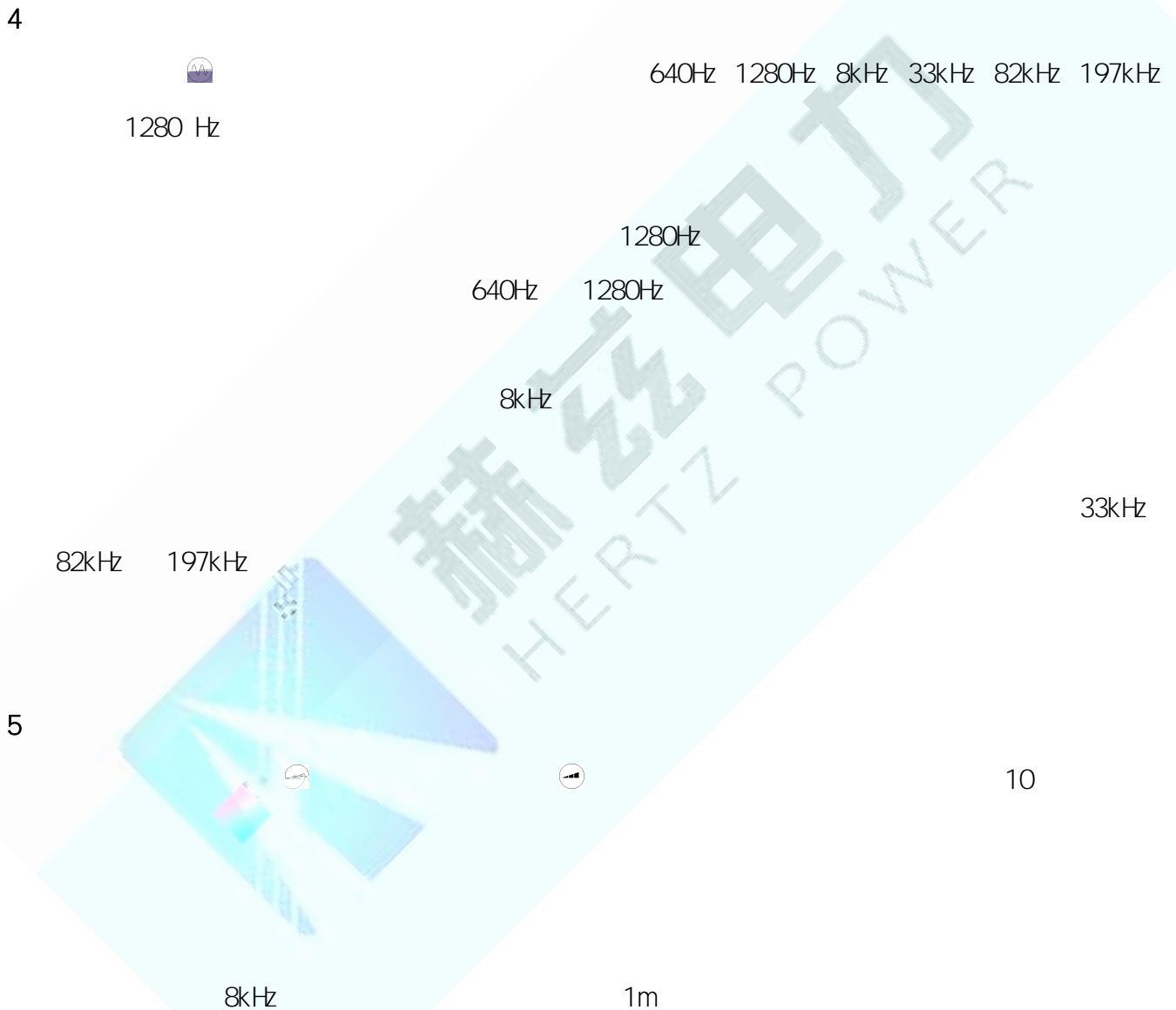

mā

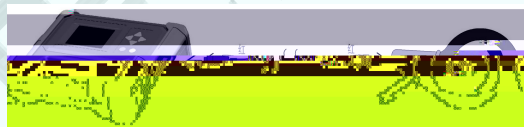

# VBI

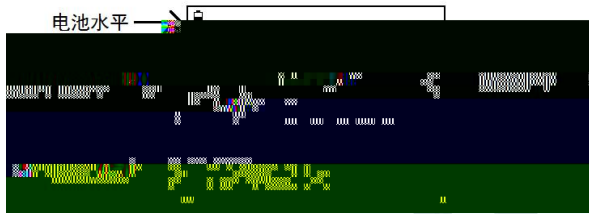

2-2-3

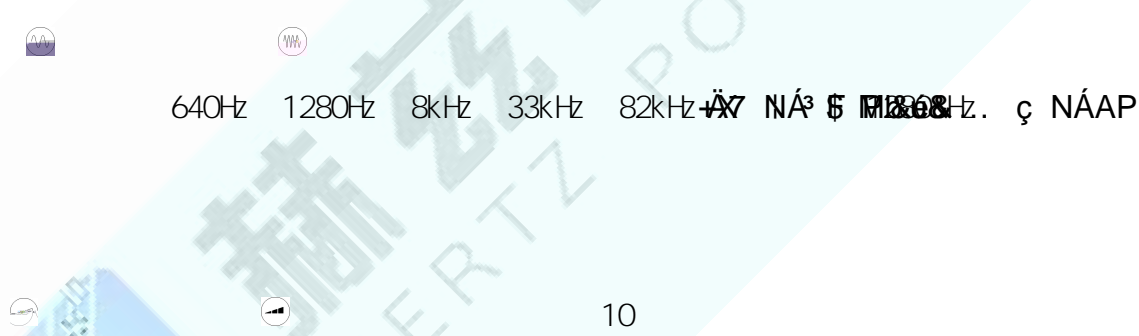

R@VÀS\$PÁ-TBPRpDQ\$ NR@ö QgRa~PjõBG NÁ  
+e \$v N@A@B (QgR@Pj@SvN# \$ @ QVKS#B@u&@. \$@ÔiRÈ ë

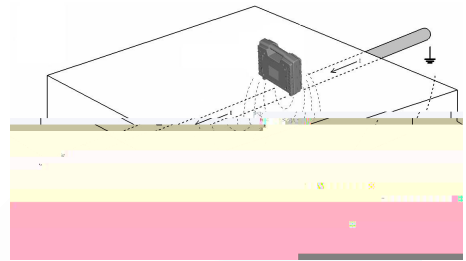

" "

2-3-1

P28

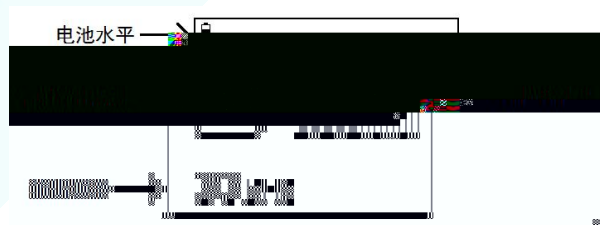

2-3-2

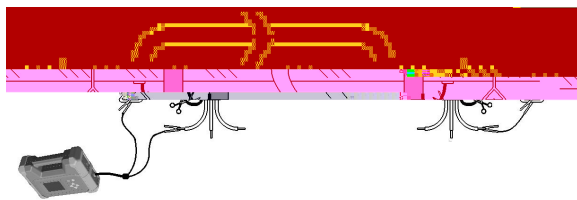

4

赫兹电力  
 HERTZ POWER

3

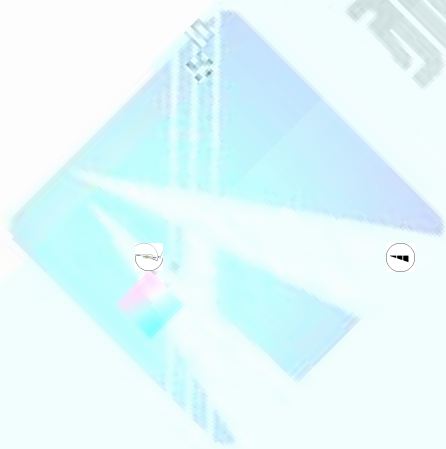

10

33KHz 85KHz 10ΔKHz 33KHz



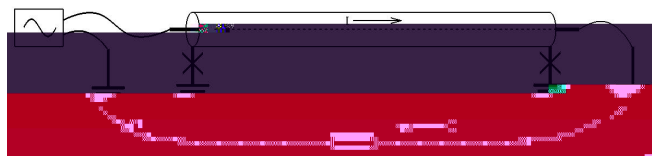

3-1-1

赫兹电力  
HERTZ POWER

2

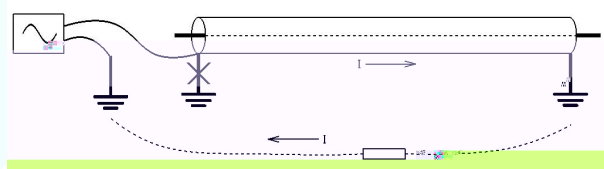

3-1-2

赫兹电力  
HERTZ POWER

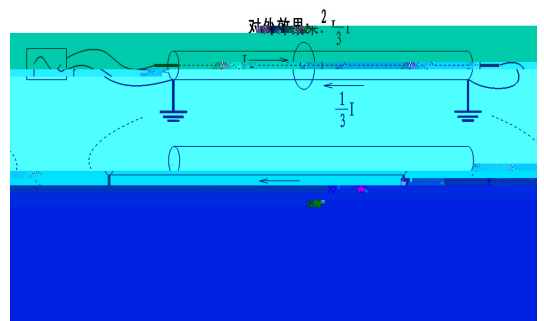

赫兹电力  
HERTZ POWER

质量可靠, 轻便易用

租到满意, 超过期

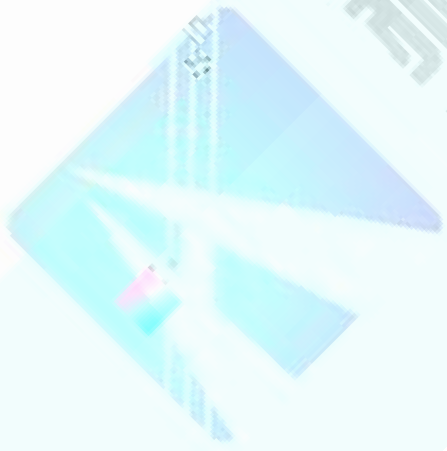

赫兹电力  
HERTZ POWER

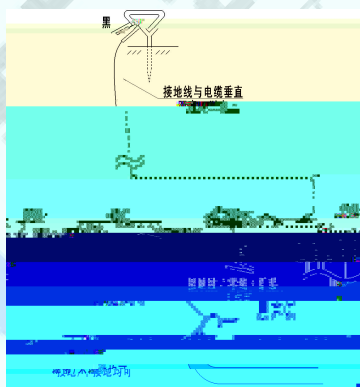

3-2-3

5m

1

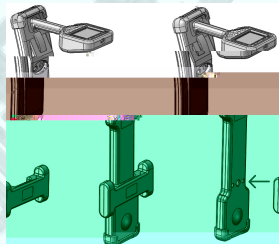

4-1-1

2



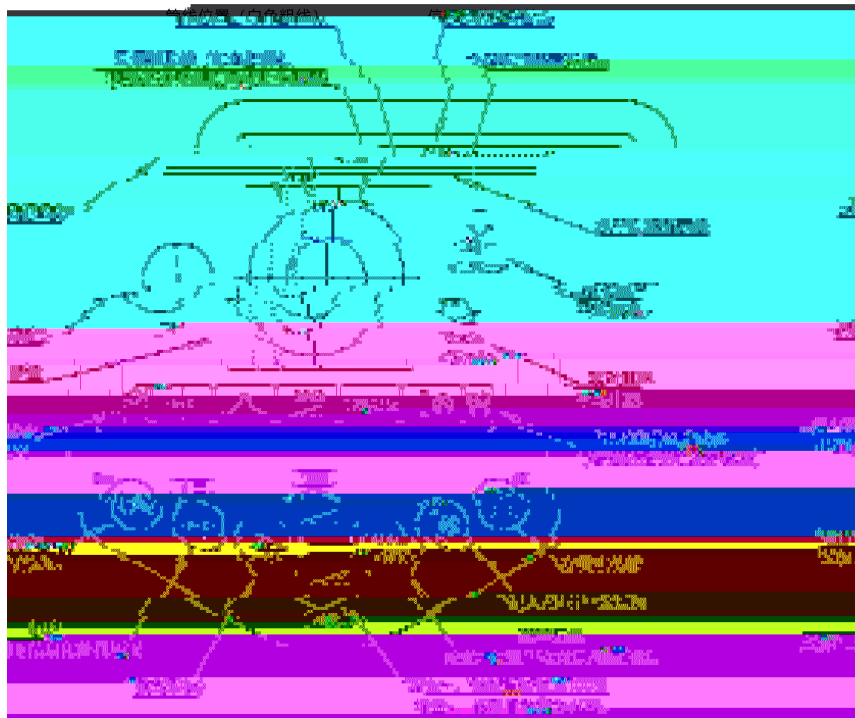

4-1-2

3 :



640Hz 1280Hz  
8kHz 33kHz 82kHz 197kHz

50 60Hz

CPS 100 120Hz



P6-P7



4







**赫兹电力**  
HERTZ POWER

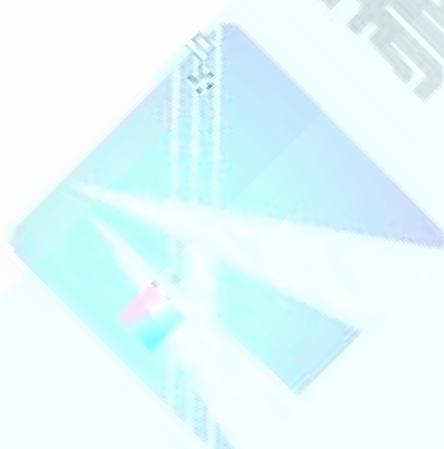

**赫兹电力**  
HERTZ POWER

20m

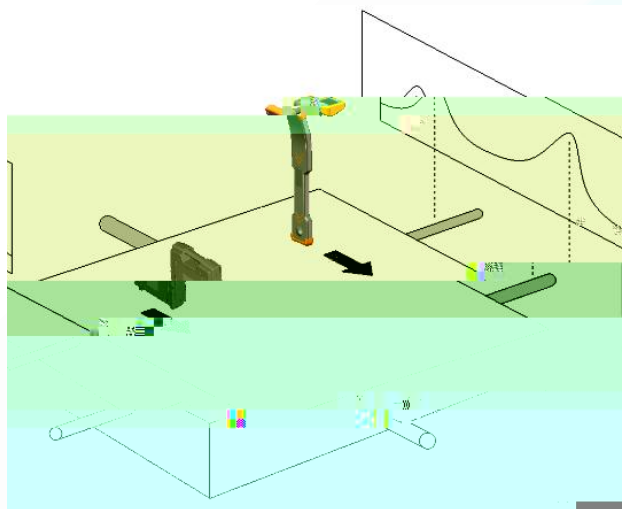

4-1-8

10

- a.
- b.

C.

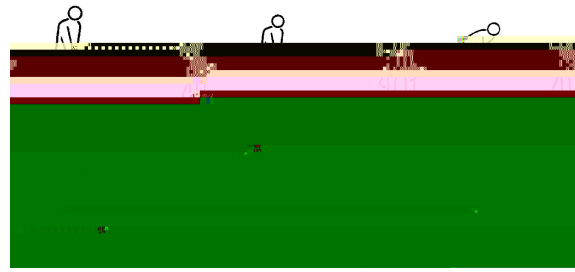

a

b

c

4-1-9

b

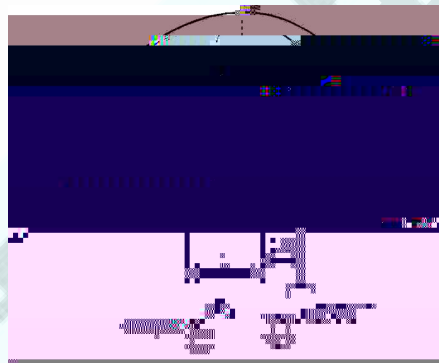

4-1-10

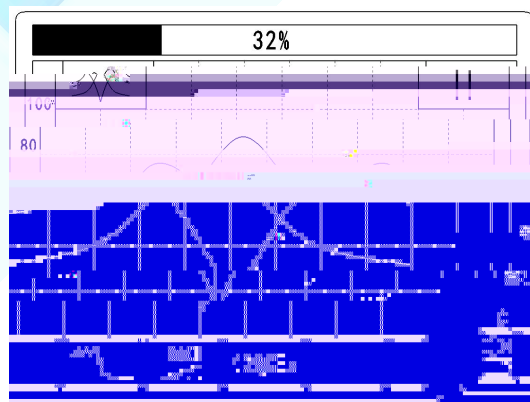

4-1-11



赫兹电力  
HERTZ POWER

产品宗旨：技术领先，质量可靠，轻便易用

服务宗旨：快速响应，**客户**到满意，**超过期**

1.

2.

3.

4.

50E÷E÷



赫兹电力  
HERTZ POWER

50E ÷ E ÷

" 48Avg "

48

600 1

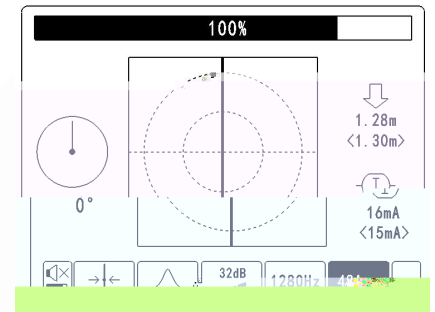

4-2-2

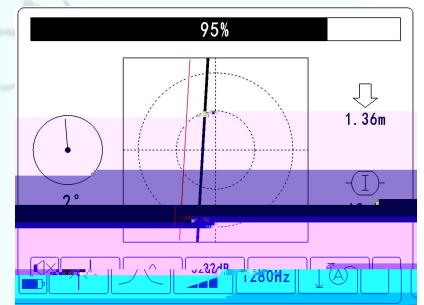

4-2-3

" " P29



# KB B



赫兹电力  
HERTZ POWER

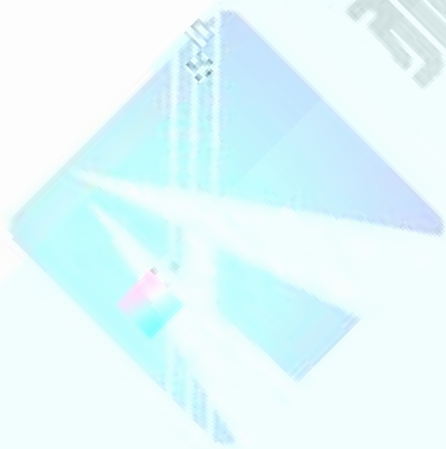



赫兹电力  
HERTZ POWER

产品宗旨：技术领先，质量可靠，轻便易用

服务宗旨：快速响应，**客户**到满意，**超过期**

赫兹电力  
HERTZ POWER

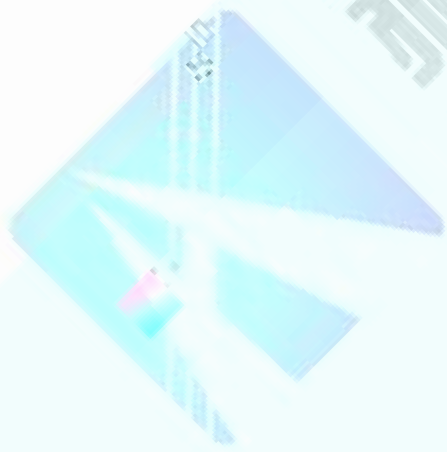



赫兹电力  
HERTZ POWER

PVR

RAD

5-1-1

2 :

3 :



ALL

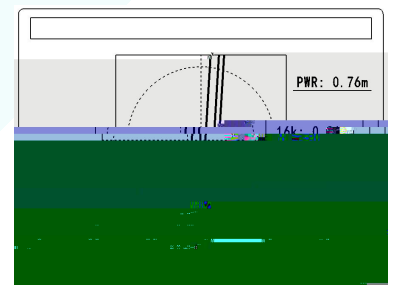

5-1-2

PVR RAD



**赫兹电力**  
HERTZ POWER



**赫兹电力**  
HERTZ POWER



赫兹电力  
HERTZ POWER

产品 技术领先, 质量可靠, 易于使用  
服务 快速响应, 上门到站, 超越期待

1

1280Hz

# 800FA

赫兹电力  
HERTZ POWER

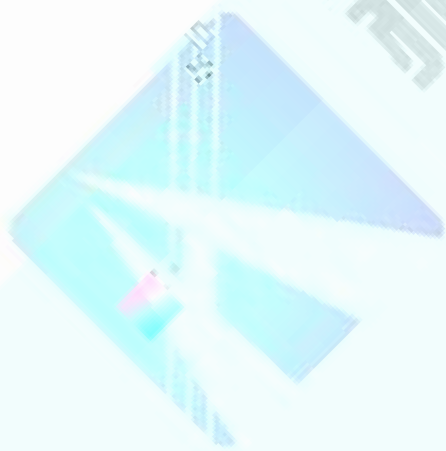

4

2m



OK

0°

5

75

120%

45°

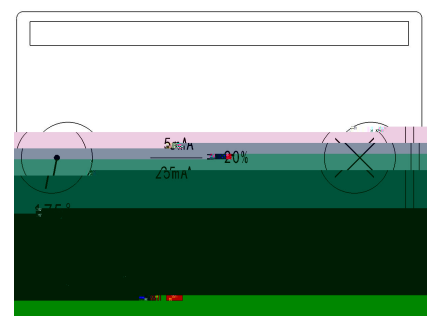
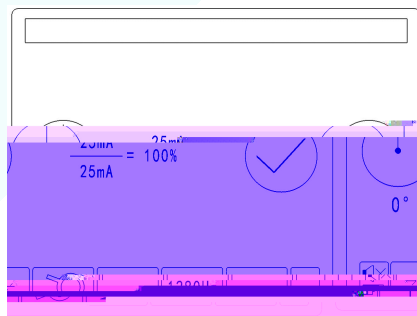
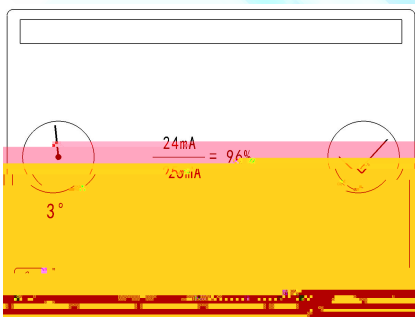



6-1-3

6.

/

180°

|

0°

|



3<1-4

1/2  
m

180t

|

0°

∅

|

8

m



赫兹电力

HERTZ POWER

产品宗旨: 技术领先, 质量可靠, 易于使用

服务宗旨: 快速响应, 客户满意, 终身服务

0 " 0 \*é " 2 \$m

D " " b 'Q6B 'l'@ {

赫兹电力  
HERTZ POWER

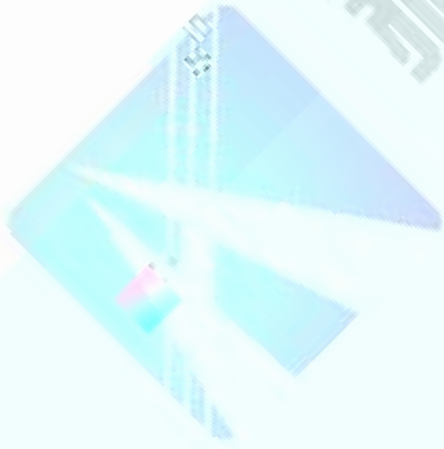

1

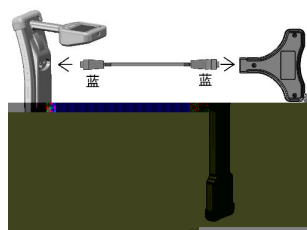

6-3-1

2

640-hz 1280-hz

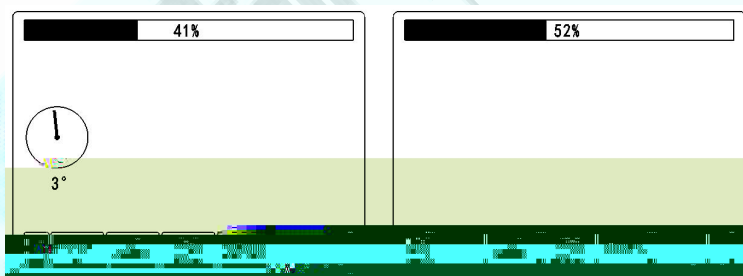

6-3-2

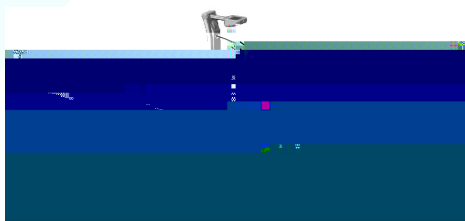

6-3-3

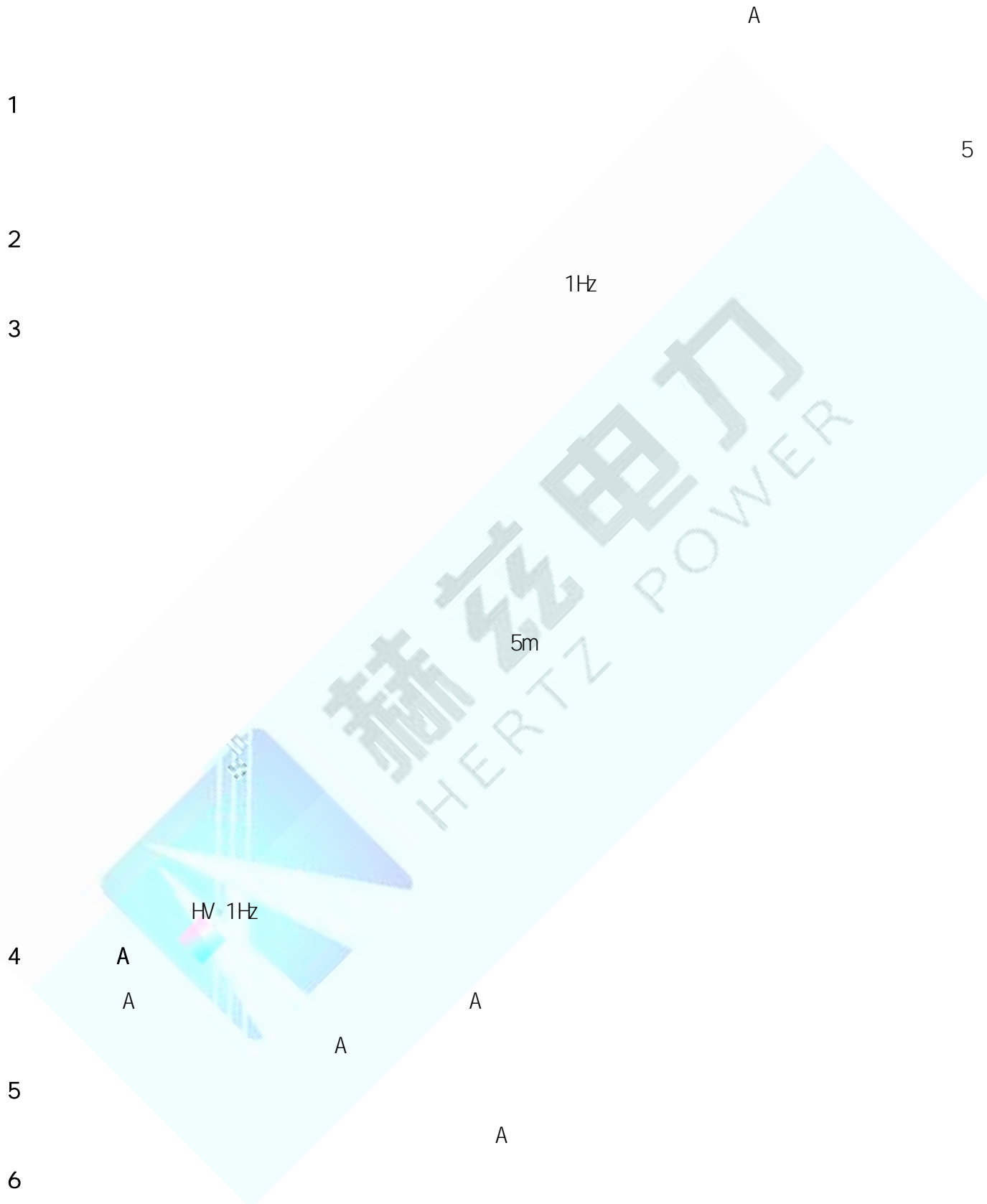



赫兹电力  
HERTZ POWER

产品宗旨：技术领先，质量可靠，轻便易用

服务宗旨：快速响应，客户满意，超过期望

555

赫兹电力  
HERTZ POWER

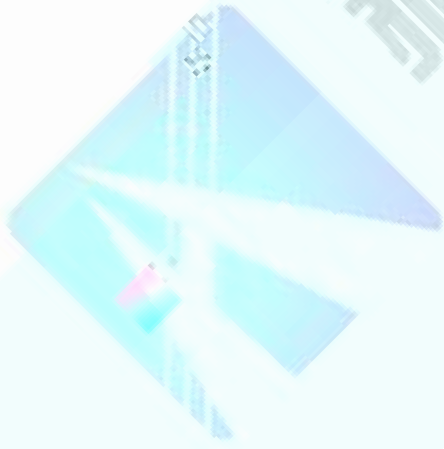

A

8

A

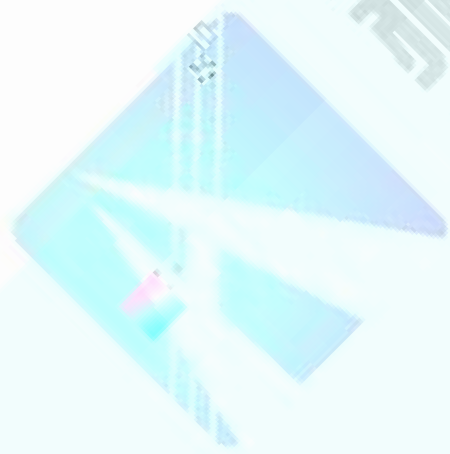

**赫兹电力**  
HERTZ POWER

3

0 10

10

10kHz

1 3

1

赫兹电力  
HERTZ POWER

1



**赫兹电力**  
HERTZ POWER

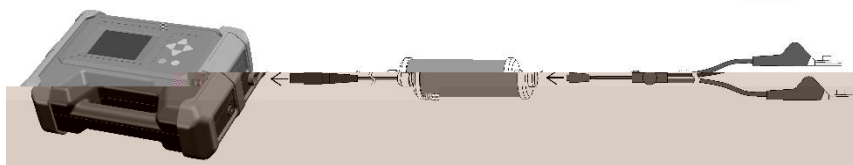

7-1-1

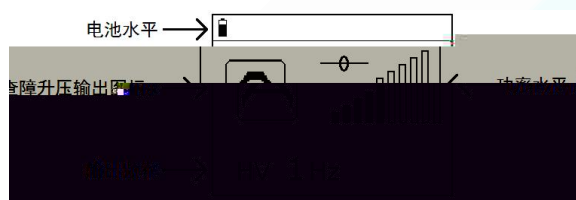

7-1-2

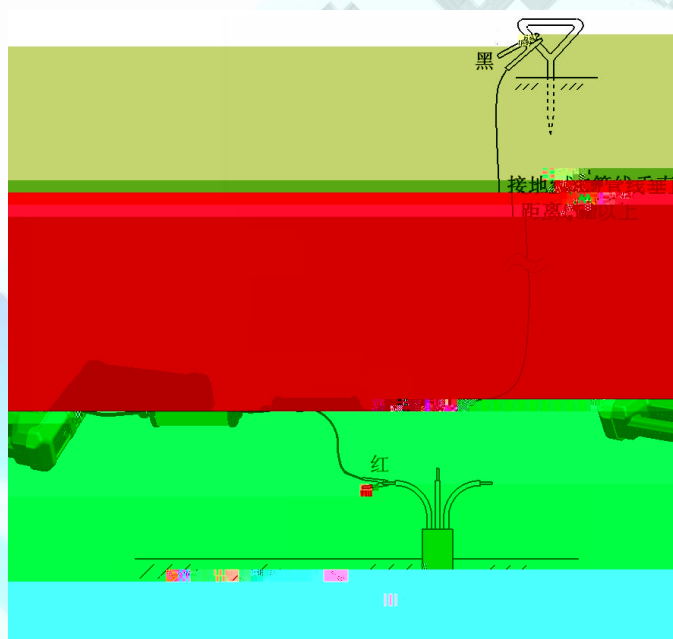

7-1-3



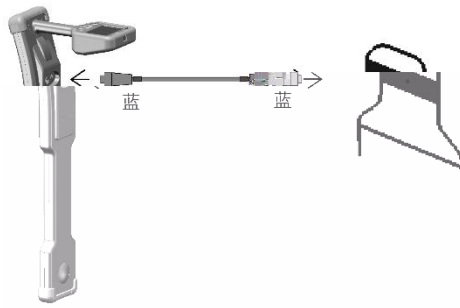

7-1-4 A

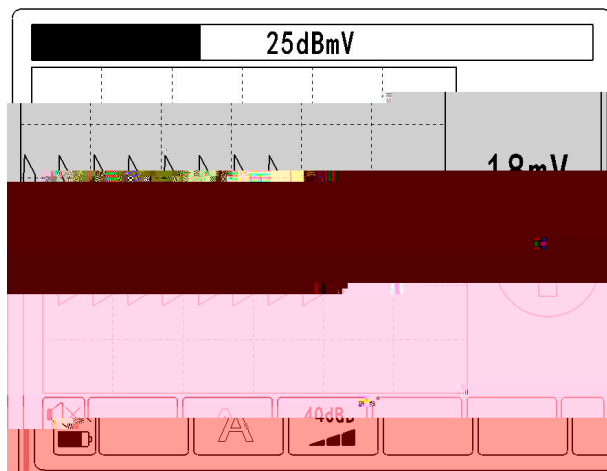

7-1-5 A

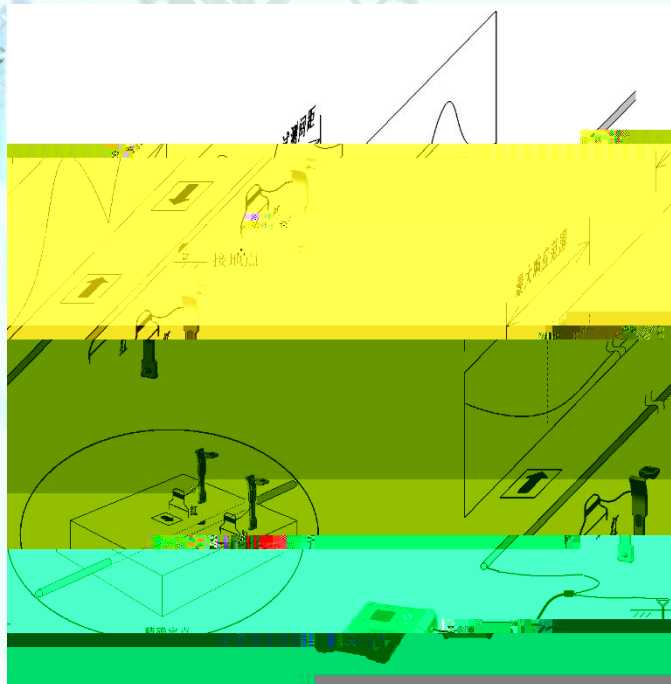

7-1-6 A

**赫兹电力**  
HERTZ POWER

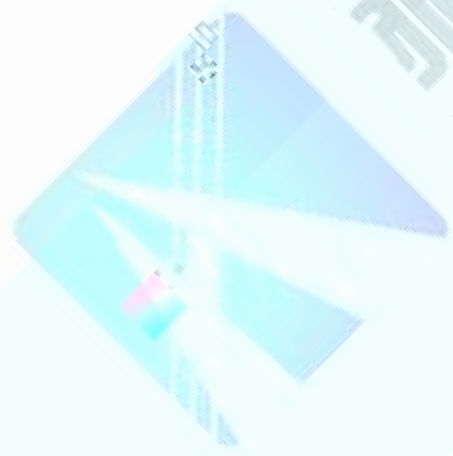

赫兹电力  
HERTZ POWER

GNSS Global Navigation Satellite System

GPS

GALILEO

GLONASS

GNSS

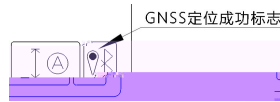

RTK GNSS

GNSS

9-1-1 GNSS

1 GNSS

L1/L5

30cm



3-5m

/

PD\_19A5, 1234, 000CBF122150

GNSS 10

2021-05-01, 09:38:16 36.12345678,N, 118.87654321,E

HDOP:0.89, Dfift:0.45m

GNSS

GNSS

10

2021-05-01

09:38:16

36.123456°

118.654321°

HDOP 0.89

1

1

0.89

0.89m

Dfift 0.45m GNSS

2

RTK GNSS

RTK GNSS

RTK GNSS



赫兹电力  
HERTZ POWER



赫兹电力  
HERTZ POWER

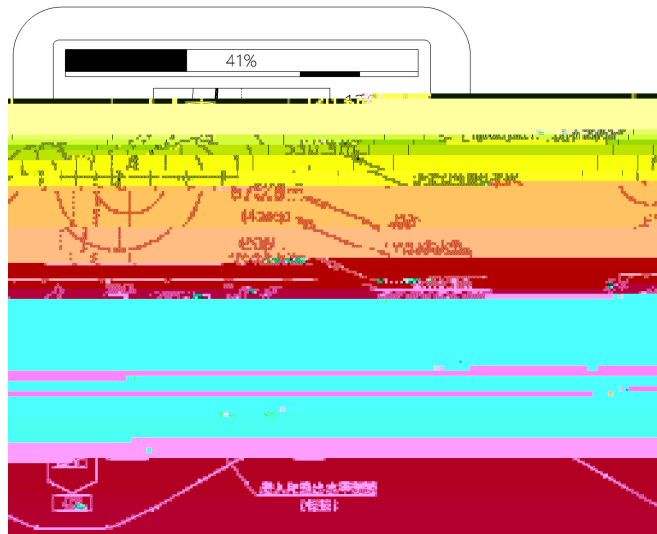

10-1-1

$$56.3m + 0.0m = 56.3m (0Dots)$$

1m



$$0.5m + 0.0m = 0.5m (1Dots)$$

$$56.3m + 0.0m = 56.3m (1Dots)$$



$$0.3m + 56.3m = 56.6m (2Dots)$$

670m

4

120m

$$120.5m + 550.3m = 670.8m (4Dots)$$

670m

4Dots

4

GNSS

GNSS

GPS

GALI LEO

GLONASS

GNSS



/

HDOP

225

027-83267669

GNSS

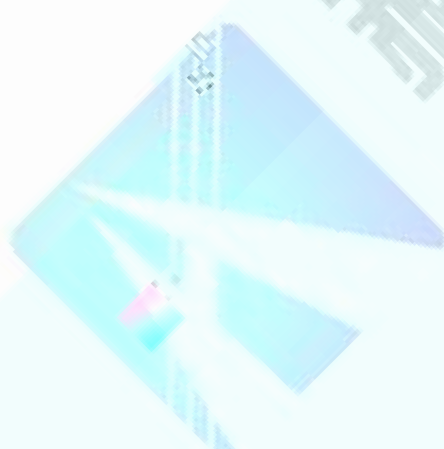

**赫兹电力**  
HERTZ POWER

Mac 00 0C BF 12 21 50

2



256

3



系统	存储	工频	单位	频率
发送全部				

/

/OK



11-1-2

3

CSV Comma-Separated Values

CSV

WORDPAD

EXCEL

GIS

\$PDTPDC, <1>, <2>, <3>, <4>, <5>, <6>, <7>, <8>, <9>, <10>, <11>, <12>, <13>, <14>, <15>, <16>, <17>, <18>, <19>\*hh(CR) (LF)

\$PDTPDC, 19A5, 126, 2021-05-01, 09:38:16, 36.0123456789, N, 118.0987654321, E, 4, 12, 0.89, 8192, 1.68, m 54, , , , \*7D(CR) (LF)

1	Frame head		\$PDTPDC	\$PDTPDC
2	UID	ID	19A5	UID

3	Count	126
4	Date	2021-06

赫兹电力  
HERTZ POWER

4

/



/

11-1-3

/OK



\*

1s

/OK



\$PDHEART, <UI D>, < Heart count >\*hh(CR) (LF)

\$PDHEART

UI D ě ;È

UI D. K̄ Heart count

6

1

8

/

—

AC220V/110V

3-4

1.5-2

300-500

/

2

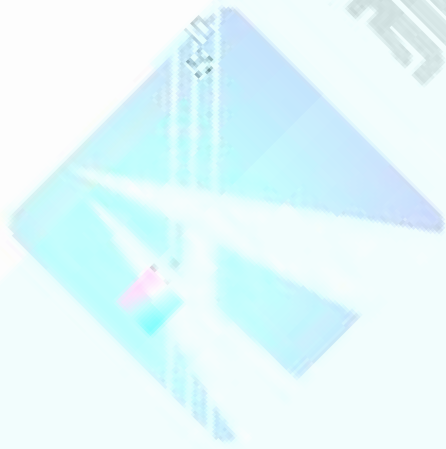

赫兹电力  
HERTZ POWER

/

1

2

1.

2

1

2

3

027-83267669

4

" " "

**赫兹电力**  
HERTZ POWER

2

24

24

48